

Varenummer: 0101108
 Beskrivelse: Seeger låsering A 120 DIN 471
 Fjederstål
 Note: Monteres med ZGA tang

Mål

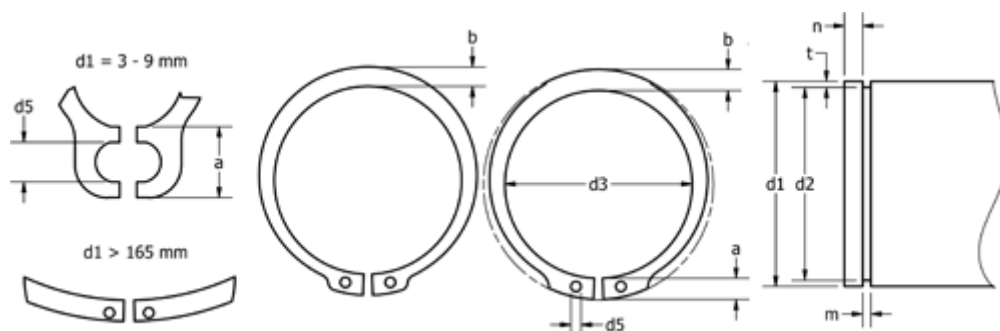

a max	= 11,0	FN kN	= 123.0	s	= 4.00
AN mm ²	= 741.0	FRg kN	= 64.50	t	= 2.00
b	= 10.2	FR kN	= 424.00	Tang	= ZGA-4
Betegnelse	= A120	g	= 3.5	tol	= -0.10
d1	= 120	K kN-mm	= 882.00	tol	= +0,54-1,30
d2	= 116.0	m min	= 4.15	tol	= -0.54
d3	= 113.0	n abl x 1000	= 4.0	vægt kg/1000	= 86.000
d5 min	= 3.5	Nominel træk	= 6.0		